



# Considerations and Strategies for Maximizing C-band Deployment

Solutions and Best Practices

## Contents

<b>Abstract</b> .....	3
<b>Introduction</b> .....	3
<b>Beamforming</b> .....	4
<b>Site Architecture</b> .....	6
<b>Coexistence with FSS</b> .....	7
<b>Supply Power</b> .....	8
<b>Small Cells</b> .....	8
<b>Fronthaul and Backhaul</b> .....	10
<b>Summary</b> .....	11

## Abstract

The recently concluded C-band auction has created new opportunities to help mobile operators address the ever-growing need for network capacity, spectral efficiency and a migration path to 5G and beyond. As with all mobile technology innovations, the benefits the new C-band spectrum provides will depend on how operators plan for and implement it into their existing legacy networks. There are a number of key challenges, including the integration of advanced beamforming technologies, the rise of massive and multi-user MIMO, site architecture issues, potential interference with fixed satellite services and use with small cells, to name a few. This white paper provides a wide-angle perspective of some of the major challenges facing operators as they consider the strategies for deploying new C-band capabilities. It also shines a light on some of the innovative developments from leading network OEMs like CommScope.

## Introduction

As we begin 2021, the first commercial 5G networks are well over a year into operation. During the past year, 5G activities have accelerated and now outpace the growth rate of all past generations of mobile technology. While 5G global deployments have utilized a wide range of the spectrum, from 600 MHz to 40 GHz, special focus is being paid to mid-band frequencies in the 3.3–4.2 GHz range. Most European nations have now assigned 3.5 GHz spectrum to operators and several networks have progressed beyond initial build-out and commercial launch. Likewise, in Asia-Pacific and the Middle East, 5G at 3.5 GHz continues to expand and mature.

3.5 GHz allocations in the United States now include the 150 MHz CBRS band which is designated for shared use with limited transmit power. As such, it is not ideally suited for macro deployment on existing sites. In December 2020, the C-band auction added another 280 MHz. This latest addition to the spectrum is regulated by rules to enable its use as a capacity overlay on macro sites with coverage characteristics similar to mid-bands around 2 GHz. Using Time Division Duplex (TDD), C-band will operate as bands n77/n78 and be fully compatible with global 3.5 MHz 5G networks. Beyond C-band, an additional 100 MHz allocation at 3.45–3.55 GHz is planned for release in 2021.

The U.S. C-band 3.7–4.2 GHz is currently used primarily for Fixed Satellite Service (FSS) downlink from space to earth. FSS includes about 20,000 operational earth station receivers which cannot coexist in the same band as 5G. Fortunately, technology advancements enable these services to continue unimpaired using just 200 MHz of bandwidth at 4.0–4.2 GHz. FSS operators will relocate to this frequency range as part of C-band refarming. The transition will take place in two phases, with a first phase of 100 MHz bandwidth (3.7–3.8 GHz) expected to be cleared for 5G use

in 46 major markets in late 2021. The remaining 180 MHz (3.8–3.98 GHz) will be added nationwide in a second phase on a timeline to be agreed upon by the parties in each market.

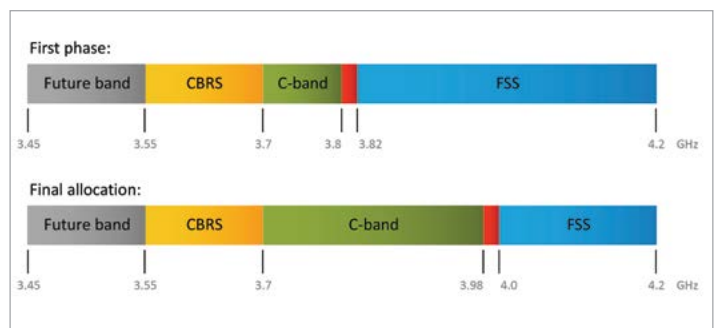

C-band refarming, first and final phases

Propagation path loss increases with frequency and the loss at C-band is about 6–8 dB higher than at the mid-bands around 2 GHz. Building penetration loss also increases by some 4 dB but this varies with building materials. The building's impact on signal loss is less severe for a wood framed home, but an industrial or office building can be left without C-band coverage throughout much of its interior. This is due to the larger building size and use of wall and window materials with higher RF attenuation characteristics. To match the coverage at lower frequencies from existing sites, the C-band path loss deficit must be compensated.

The solution to the coverage problem is beamforming. The 5G NR standard supports beamformed control channels and traffic channels; whereas, beamforming in LTE is limited to traffic channels. Downlink (DL) coverage is defined by the control (broadcast) channel. Beamforming allows C-band coverage to closely match that of LTE at 2 GHz. The C-band uplink (UL) budget is still more limited, however. It is sufficient for maintaining a

connection (control plane signaling) but may need help with uplink traffic (user plane) around the cell edge. In these cases, a common solution is dual connectivity, where LTE at the lower bands complements the 5G UL. As lower bands migrate to 5G NR, the same or better improvement can be achieved with carrier aggregation.

## Beamforming

Base station antennas contain arrays of radiating antenna elements (AE). When the antenna is powered, it feeds the AEs with individually controlled amplitude and phase that shape the beam. In a conventional antenna, built-in power dividers and phase shifters shape the beam and additional features help refine and optimize the beam shape. Remote electrical tilt (RET) adds the ability to shift the beam in the vertical plane on an infrequent basis.

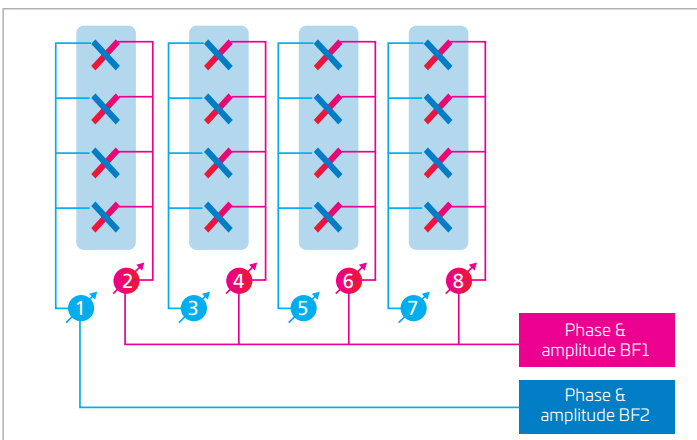

Beamforming with four-column antenna

In the context of LTE and 5G, *beamforming* refers to the ability to steer the beam in different directions between short time intervals. With digital beamforming (precoding), a different beam direction for each resource element (subcarrier and symbol interval) in the modulated 5G signal is possible. The power dividers and phase shifters are removed from the antenna. Instead, amplitude and phase are controlled by *weights*, driven by software settings. The advantage of this flexibility is apparent, but involves some compromises:

- To control each AE independently, a large number of radio ports (along with their associated costs) would be required. AEs are therefore grouped into *subarrays* controlled by a limited set of ports and weights. This *quantization* causes suboptimal beamshaping and relatively higher sidelobe levels.
- Amplitude weights cannot be increased beyond the capability of each radio port. Therefore, beamshaping with amplitude requires a reduction in power, which impairs coverage. Using full power is usually preferred but beam control is less precise.

- The fixed beam refinement features of passive antennas cannot be used in beamforming antennas if they interfere with any beam shape expected to be formed.

Beamforming antenna panels consist of radiating AEs arranged in rows and columns. The size and shape are specified as “*columns x rows x polarizations*”. Common larger panels for C-band include 8 x 8 x 2 with 128 AEs and 8 x 12 x 2 with 192 AEs. Cross-polarized elements are standard. The columns are then divided into subarrays—grouped adjacent elements of the same polarization. The number of antenna ports is reduced to match the radio, which can have 64, 32 or 16 transmit/receive ports. The radio and antenna are integrated into an active antenna unit (AAU) designated as 64T64R, 32T32R or 16T16R. These configurations are commonly referred to as the massive MIMO (m-MIMO) options for LTE and 5G below 6 GHz.

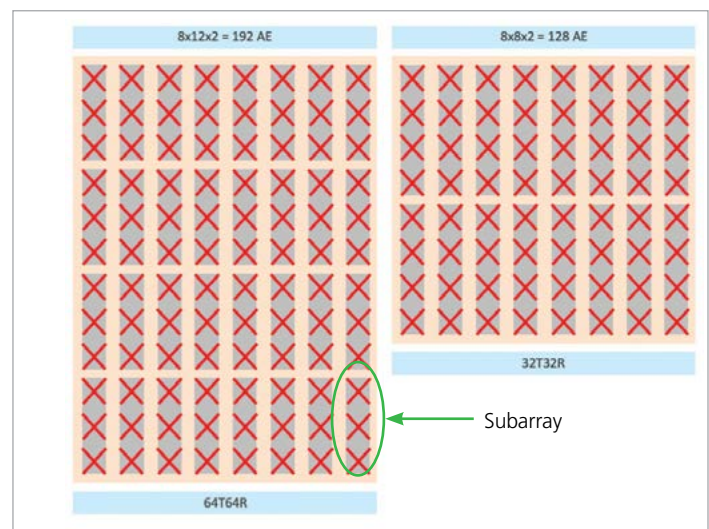

Examples of massive MIMO antenna panels

The three m-MIMO configurations differ in the following ways:

- 64T64R and 32T32R support horizontal and vertical *beamsteering*. The smaller subarray size of the 64T64R (2–3 AEs) permits a larger steering range in the vertical dimension with better vertical sidelobe rejection, while quantization sidelobes limit the usable steering range of the 32T32R configuration. 16T16R only supports horizontal beamsteering, since each subarray comprises a full column of elements.
- The arrays can be designed with a *pre-tilt* of several degrees (downtilt). Vertical beamsteering will then be up and down, relative to the pre-tilt angle. RET is implemented on only some 32T32R and 16T16R units.
- Radio output may vary and is measured in either total watts of RF power (equally divided between the ports) or as effective isotropic radiated power (EIRP). The latter combines output power and maximum antenna gain produced by beamforming.
- Note that maximum antenna gain is determined by the antenna panel size and is independent of the port configuration. The spacings between columns and rows, expressed in wavelengths, also influence gain,

beamwidth and sidelobe levels. The best sidelobe rejection is obtained with one-half wavelength spacing. Designers commonly adhere to this spacing between columns. Row spacing sometimes departs slightly from the one-half wavelength rule in order to meet other pattern shaping objectives.

The above broadly summarizes the current and prevalent m-MIMO options, but many other configurations have been proposed and we can expect the technology to continue to evolve.

The introduction of 5G at 3.5 GHz raised interest in the promise of m-MIMO. Many deployments began in dense urban areas that most needed capacity enhancement. AAU equipment with m-MIMO became available early. Dense urban environments are suitable for vertical beamsteering, allowing beams to be pointed at higher floors of tall buildings. Short intersite distances (ISD) and horizontal user-distribution characteristics also help leverage multiuser MIMO (MU-MIMO) to significantly boost capacity. MU-MIMO may not be exploited as effectively in the vertical dimension, however. Once AEs are grouped into subarrays, the preferred half-wavelength spacing no longer applies in the vertical dimension. Sidelobes in the vertical antenna pattern limit the angular range covered by current m-MIMO implementations. European operators have also experienced poor service inside high-rise buildings due to the use of popular building materials that create high penetration signal losses at 3.5 GHz. This negative becomes a benefit when deploying or upgrading indoor coverage systems for C-band. In this case, the building materials serve to contain interference from outdoor sources, enabling superior indoor performance.

*Massive MIMO* is not the only beamforming option for C-band, however. As deployments expand to suburban and rural communities the absence of high-rise structures diminishes the

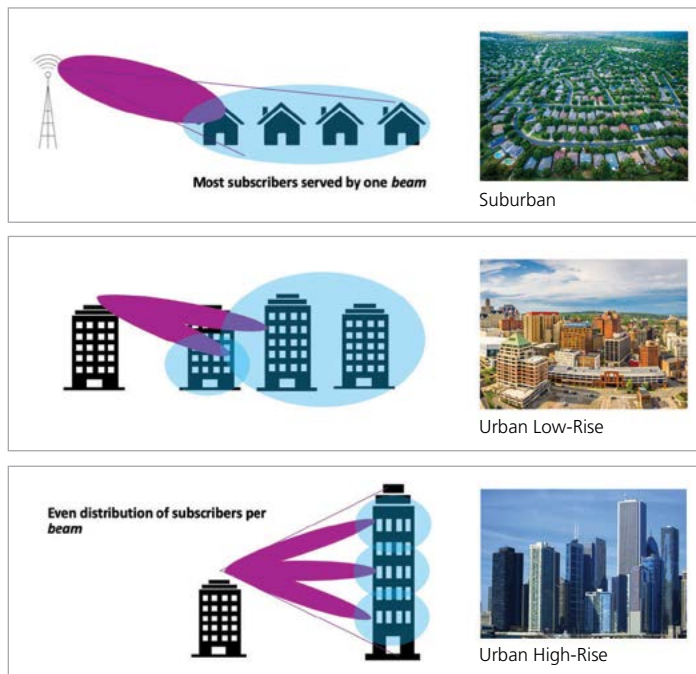

Downtilt and vertical beamsteering for different environments

usefulness of vertical beamsteering. With a larger intersite distance, most of the cell area can be covered optimally by a beam at a fixed elevation angle in the conventional manner. In these scenarios, horizontal beamsteering is more helpful in providing extended coverage and better user throughput.

Lower traffic loads result in ample cell capacity and little need for MU-MIMO. The trend in maturing markets is now towards 8T8R as the dominant beamformer configuration for these areas. 8T8R systems have been widely used in TD-LTE networks and their performance is well understood. Unlike m-MIMO systems, 8T8R systems are mainly constructed with a separate RRU and antenna and interconnected by jumpers, but an AAU is also an option. As of the writing of this document, MU-MIMO is not yet supported in the 8T8R RRUs being introduced, but it is expected to become available as a software upgrade, further expanding the use cases for 8T8R.

Conventional 8T8R antenna panels have four columns of AEs while the row count varies (e.g. 4 x 15 x 2 with 120 AEs). The four column panel produces about twice the horizontal beamwidth (HBW) of an m-MIMO panel with 8 columns. This reduces the gain by a nominal 3 dB but some of the reduction can be offset by making the antenna longer; for example, using 15 rows instead of the 8 or 12 currently offered in AAUs. Like the 16T16R configuration, the 8T8R subarrays comprise the full column and therefore support only horizontal beamsteering. RET enables the necessary downtilt adjustment. CommScope has now introduced an "8T8R+" design that goes beyond the conventional concept to produce sharper HBW with additional gain and better sidelobe suppression. As beamforming moves into the mainstream, we can expect further innovations and technical refinements.

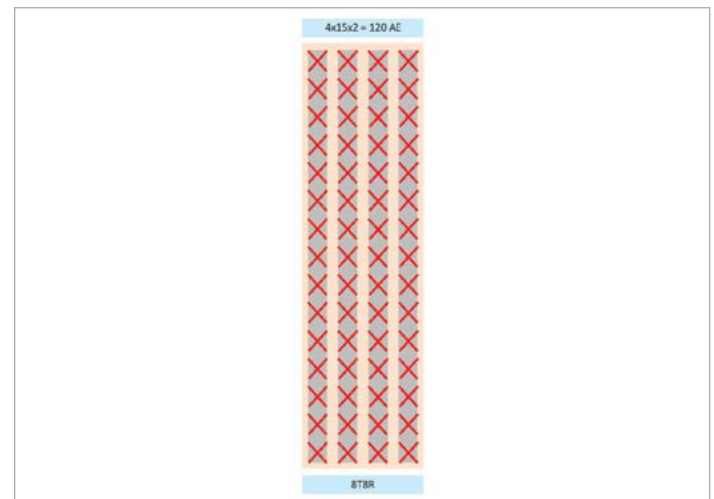

Example of 8T8R antenna panel

Currently, many operators are settling on two solutions for macro overlays: an m-MIMO configuration for dense scenarios and 8T8R for less demanding areas. The latter typically includes suburban and

rural environments. Low-rise urban areas often use mixed strategies that may be dominated by one solution or the other. The preferred m-MIMO option is 64T64R which offers the best performance, but 32T32R has also attracted a following. Both 8-row and 12-row variants of beamforming antenna panels for m-MIMO are offered as well as different power levels. 16T16R has not found favor among 3.5 GHz network designers.

## Site Architecture

While beamforming helps match C-band coverage to that of lower bands at macro sites, non-beamforming 4T4R, and even 2T2R radios and antennas, can be used in small cell and mini-macro applications (discussed later). Whichever option is chosen, C-band requires new radiating arrays which must often be deployed on frequently congested towers and roof tops. Based on site conditions and other objectives, operators can choose to follow one of three upgrade paths:

**N+1:** This upgrade path adds a standalone passive or active C-band antenna (+1) to one or more existing “N” antennas. Naturally, this requires the available space and wind load capability to support the additional antenna. The upfront equipment cost is minimized and there is no need to touch the existing antennas, simplifying installation and leaving legacy networks undisturbed.

**1+1:** In a 1+1 upgrade, existing passive antennas are consolidated into a single antenna with multiple ports/arrays. This frees up space for the new C-band equipment, making this solution a good fit where extra space is not available or lease costs are high. Another good use of 1+1 is when legacy bands and technologies are due for an upgrade—to higher MIMO schemes, spectrum extension/refarming, etc. Replacing aging antennas with advanced multiband designs can provide better performance and reliability, additional functionality and reduced structural load, while operators prepare for future upgrade phases.

**TopBox:** The TopBox is a 1+1 variant from early 3.5 GHz deployments. It consists of a 3.5 GHz AAU or passive beamformer mounted above a low/mid-band antenna. These are positioned behind a shroud that forms an extension of the passive antenna radome to create the appearance of a single antenna. The TopBox has the flexibility to accommodate a variety of AAUs, but the low/mid-band antenna may need to be shortened to meet total length limits. This would reduce gain, primarily in the low band <1 GHz.

**All-in-One:** Where space is limited to a single antenna, an All-in-One assembly enables the addition of C-band to existing services. An all-in-one features a modular antenna whose low-band arrays extend the full length of an undivided radome for unimpaired performance. Shorter, passive mid-band arrays fill the lower part



### Site Architecture Options

of the radome, leaving space above for the C-band arrays which are installed as a separate module. The solution can be deployed with a 32- or 64-port AAU or an 8-port passive antenna. The design accommodates different makes and models but requires a mechanical interface kit for each style.

For 8T8R deployments, passive multiband antennas are also available with various array configurations including low-band FDD, mid-band FDD/TDD and 3.5 GHz beamformers. These antennas are ideal for 1+1 or all-in-one upgrades requiring the lowest capital

investment. More operators now prefer these solutions as they follow the trend toward combining more arrays and bands into the same antenna.

Higher MIMO schemes for low and mid bands along with beamforming antennas in the high bands result in multiple connections between radios and antennas. Recently introduced [cluster connectors](#) group four or five coaxial cables together to save space on antenna end panels and help prevent misconnections. Competing standards are currently offered with the CommScope designed M-LOC attachment gaining favor for its superior intermodulation performance and quick, no-tools installation. M-LOC is now featured as the standard or optional interface on a growing selection of CommScope antennas and is also available on other manufacturers' products. The HELIAX® M-LOC solution can be used for all antenna connections or in combination with 4.3-10 connectors. Cluster connectors are the go-to option for C-band 8T8R. M-MIMO AAUs, it should be noted, do not require interconnection cables since radios and antennas are integrated.

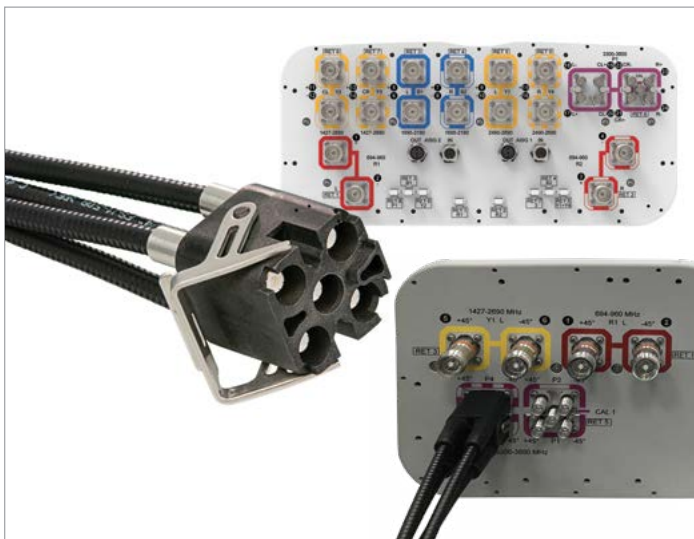

HELIAX® M-LOC Cluster Connector System

## Co-existence with FSS

To complete the first phase of C-band refarming, FSS operators must vacate 120 MHz of spectrum, including 20 MHz of *guard band* at 3.80–3.82 GHz. C-band operators must then take necessary measures to avoid interfering with the very sensitive FSS receivers at 3.82 GHz and above. In the second phase, the guard band will move to 3.98–4.00 GHz with interference suppression required in 4.00–4.20 GHz.

On the C-band base stations, the rules impose stringent out-of-band emissions (OOBE) requirements. A limit has been set on the level of interference from each base station received at any satellite earth station, expressed as a maximum power flux density (PFD) of -124 dBW/sqm in a 1 MHz bandwidth. That limit can then

be translated into the maximum interference power the C-band radio may feed to its antenna. The translation will depend on the gains and orientations of both the C-band and the earth station antennas, as well as the distance between them. With “normal” OOBE specifications—as they apply to radios for most other frequency bands—the distance would need to be several km in many cases. That would mean unacceptable restrictions on the C-band deployment; so, extraordinary measures are needed to improve OOBE.

How much improvement is enough? The answer will vary depending on the proximity of the sites to each other and whether the antennas are pointing away from or toward each other. There is also variability in local propagation conditions. Sample calculations give results from a few dB to perhaps 50 dB of additional OOBE rejection. While 50 dB may appear sufficient, it may not always be enough, so a solution should preferably provide additional margin if possible.

OOBE is most effectively suppressed using an [interference mitigation filter \(IMF\)](#), installed between each radio port and the antenna, and often integrated with the radio's output filter. The challenge presented by C-band is that different filters will be required for phase 1 and phase 2 refarming. In practice, radios will be designed for full band phase-2 operation, including the IMF feature to suppress the ultimate 4.00–4.20 GHz FSS allocation. During phase-1 implementation, an interim IMF is needed that can suppress the 3.82–4.00 GHz range then be removed for the transition to phase 2. It is important that the interim IMF can be removed without sending a tower crew to each site.

The CommScope IMF solution is available for 8T8R systems and is installed between the RRU and passive antenna. These filters achieve 60 dB OOBE suppression which may allow base stations to operate as close as 100 meters from an FSS earth station antenna. Eight filters are included in a single package with a volume of less than 4 liters.



8T8R FSS interference mitigation filter

Inline connectors facilitate installation below or behind the antenna. The filters can be bypassed by remote command to allow instant transition to phase 2. The remote interface uses the standard AISG protocol already supported by controllers in the radio.

The interim IMF solution will not work for a m-MIMO AAU. So, in phase 1 other interference mitigation methods must be used. Since beamforming can create nulls as well as peaks, one option is to use weights to minimize radiated energy in the direction of earth stations. Sidelobes, including quantization lobes, must be considered as well. There are concerns how this might be implemented consistently in the field. Another option may be to reduce overall output power of the AAU. OOB E will then also drop, and at a faster rate. In short, operators must overcome significant challenges if they are to avoid performance degradation in both C-band and FSS when m-MIMO is deployed in phase 1.

## Supply Power

Each bit of information transmitted in the downlink consumes energy. With throughput demands showing no signs of abating, power delivery and energy efficiency are receiving increased attention from operators. Radio OEMs are responding with innovations that reduce energy waste. These include schemes to shut down idle circuits during low traffic hours or dynamically in millisecond intervals. Beamforming, by its nature, improves efficiency by concentrating energy in useful spatial directions. Noise and interference slow transmission and drive higher cell loads; so, a high performing network is also energy efficient. With these various factors at play, it is difficult to compare the overall power consumption of different MIMO and antenna options. Feedback from operators indicate that m-MIMO roll-outs have led to a notable uptick in energy usage. As a result, mobile networks must make more judicious decisions regarding the most suitable solution for each service area.

The choice of MIMO solution also impacts power delivery to the radios. A robust power feed must be able to maintain sufficient voltage at the radio during peak power demand and when the site relies on backup battery power. Failing this, radios will shut down causing the site to go out of service. When adding C-band, the existing power feed should be evaluated and may need to be upgraded. The rated peak power demand of a 64T64R radio is about 50-percent higher than that of an 8T8R radio of the same total RF output, e.g., 320 W.

We know from Ohm's law ( $V = I \times R$ ) that voltage (V) drop in the power feed can be reduced by lowering the cable resistance (R). This is done by increasing the cable thickness or by installing additional cables. Things to consider when deciding the best solution include the added weight and the cost to specify, purchase and install the new power trunks. Unfortunately, backup batteries' condition, age, service history etc., is often not well-known; such uncertainty leads to added design margins that often result in an over-dimensioned, higher-cost power feed.

The other alternative, based on Ohm's law, is reducing the current (I). Given that the peak power demand of the radio is a fixed value, how can we do that? Power (P) can be defined as  $P = V \times I$ . To *reduce current*, we must *increase voltage* to compensate. While the battery voltage is nominally 48 V, radios can typically accept up to around 57 V. By utilizing this headroom, we can reduce the current draw proportionally. If we can regulate this higher voltage at the radio, so that it is unaffected by the voltage drop in the cable, we can achieve the minimum possible current draw. CommScope's [PowerShift®](#) solution is built on this principle. PowerShift boosts the power-carrying capacity of any size power trunk; the amount of boost achievable varies by circumstances but a doubling of the capacity is not uncommon. PowerShift also enables the backup batteries to deliver all stored energy to the radios, which is otherwise not possible. Thus, both trunk replacement and battery upgrades can often be avoided, making PowerShift a quick and economical method for delivering a robust power feed for C-band overlays.



PowerShift® main shelf with two boost modules

## Small Cells

Outdoor small cells take many shapes, including the [metro cell](#) pole which often incorporates a street light luminaire. These poles typically do not exceed 40 feet in height, keeping their antennas well below the building tops in most urban environments. This not only affects signal propagation and coverage, it defines the metro cell's role in the network. These sites fill coverage holes in the macro network or augment capacity in local traffic hotspots. As their antennas are typically omnidirectional, coverage is shaped largely by the layout of surrounding buildings. Antenna performance, and vertical pattern shape in particular, still remain important to control interference between sites and coverage in parks and other open areas. Typical antennas are pole-top mounted, canister-shaped and limited to 2–3 ft in length. They contain arrays for all or some of the low band (<1 GHz), mid band (1.7–2.7 GHz) and the 3.5 GHz and 5 GHz high bands. High port-count models are available, intended for use by multiple operators. Metro cells can also carry mm-wave (24–40 GHz) 5G radios with integrated antennas, stacked below the pole-top canister.

Small cells can also be used for primary coverage, extending or replacing the macro network. This is appropriate for secluded or



isolated communities that do not require macro capacity. Taller towers can be installed to improve coverage reach. A step up from small cells, mini-macro site designs are also found in this environment. For C-band deployment, small cell and mini-macro antenna options range from 4-port quasi-omni arrays (in pole-top small cell canisters) to 8-port beamformers. 4-port sector antennas are available as well. 8-port radios have been announced that can be configured to serve multiple sectors with 2T2R or 4T4R and help operators implement a capacity growth path that matches the demand in each sector.

In areas with above-ground utilities distribution, strand mounted small cells are an attractive alternative. Strand mounting does not require a pole attachment and can simplify site acquisition, and power and telecom connections. Compact 4-port strand mounted antennas are also available. For 3.5 GHz applications, strand mounted small cells are already used in the CBRS band for HetNet and fixed wireless access (FWA) applications. These same use cases could be addressed with C-band.

On the design side, today's metro cells present some daunting challenges. In addition to requiring multiband, multi-operator communications equipment, they may also need to support capabilities such as lighting, cameras, environmental sensors, etc. The complete assembly must be space-efficient and blend into the architectural landscape while meeting structural, cooling, regulatory and safety requirements. It should also be easy to transport, erect and maintain – and competitively priced. The strong interdependence between these constraints is best managed through an integrated

engineering process that results in a turnkey product. CommScope's continuing success in resolving these challenges comes largely as a result of our leadership in all key technologies, from structural and thermal engineering, cables and interconnects to power systems and the entire RF path. Today we offer a broad portfolio of attractive solutions. Recent additions include the innovative [CellSign](#) with customizable graphics and a "donut" shaped canister antenna for poles with top mounted luminaires.

As large numbers of outdoor small cells are distributed in public areas, power and mobile network connections present different challenges. A common solution has been to obtain AC power from the local grid. While this seems straightforward, coordinating the installation with utility companies and their specialist crews frequently becomes a stumbling block, resulting in delayed rollout and extra costs. At the same time, the increasing reliance on small cells has raised the demand for uninterrupted operation, increasing the need for battery backup which must be located and maintained on site. With AC power, the fronthaul/backhaul connection becomes a separate step in the process, involving different crews. Worst case, digging and trenching is done twice for a single site.

An alternative to grid power is a separate power feed from a central location controlled by the mobile operator. CommScope's [PowerShift Metro](#) solution eliminates the need for an onsite power rectifier and meter, relieving equipment congestion at the small cell pole. Grid power is only required at the centralized hub, meaning operators can simplify maintenance and realize greater OpEx savings. Batteries at the *power hub* can provide backup to an entire cluster of small cells. Perhaps the strongest advantage is that the power cabling and fiber connection can be integrated and routed together. This solution is compliant with the latest standards for distributed power connectivity. PowerShift Metro delivers kilowatts of power and up to 144 fiber strands in a single composite cable that can serve multiple nodes along each "spoke" from the power hub. Built-in safety features enable non-certified electrical personnel

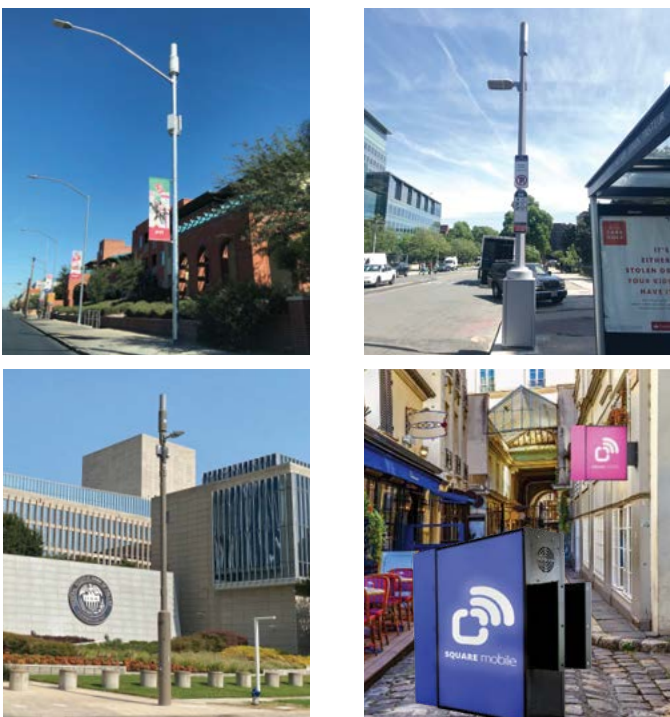

Metro Cell and CellSign concealment examples

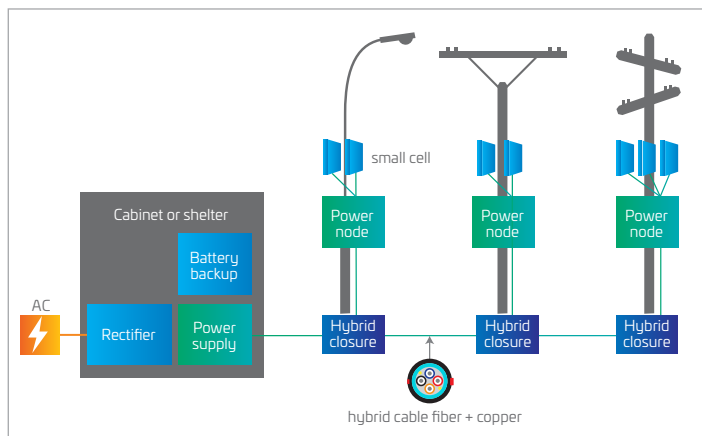

PowerShift® Metro basic configuration

to install the solution. In most cases, the cable can be co-routed with other communications cabling. PowerShift Metro can also be leveraged to supply various types of infrastructure such as FWA access points, mobile edge computing and hybrid fiber coaxial cabinets, and smart city installations.

## Fronthaul and Backhaul

As user demand grows, more user data must be transported to and from the core network along with control plane information. While this can be done via a [microwave](#) link, [optical fiber](#) transport is preferred. Where there is a relative abundance of low-cost “dark” fiber, enabling user data transport can be as simple as dedicating a fiber pair for each radio or set of radios that are able to natively share a fiber pair. In many locations, however, the high cost and time required to lay additional fiber drive operators to lease capacity on existing fiber networks. This creates additional challenges to deliver performance and reliability and to maximize utilization of each fiber run in order to optimize OpEx. The same can also apply where the fiber plant is owned but capacity is nearing its limit. Fortunately, technology keeps evolving and various methods to enhance capacity are now in the mainstream and can be applied to legacy single mode fiber already in the ground.

The ceiling on data rate in each fiber channel has been steadily increasing over the past two decades. While some 1 Gbps links may still be found, 10 Gbps has been the mainstay for several years and is now being superseded by 25 Gbps. Upgrading to higher data rate requires replacing the optical transceivers at each end. Beyond the fiber link, switches and routers in hubs and the central office may also need to be upgraded.

Wavelength division multiplexing (WDM) is used to further multiply the data-carrying capacity of each fiber strand. In a dark fiber, coarse WDM (CWDM) can multiplex 16–18 channels, each at the full data rate for both the downlink and uplink directions. Each channel uses one wavelength (or “color,” as usually drawn in diagrams). Dense WDM (DWDM) can pack 25 channels within the bandwidth of a CWDM channel. It is not suitable for the full range of wavelengths, however. Standard DWDM provides 40 channels and only utilizes part of the spectrum, which can help reduce leasing costs. However, optical devices for DWDM demand better precision than CWDM and currently command a higher price. Double density DWDM (80 channels) and subchannel CWDM are other capacity enhancing schemes that may find future application in RAN connectivity.

WDM is an enabling technology for converging fronthaul and backhaul for mobile networks with other optical networks. A single leased fiber can provide enough bidirectional capacity for one or more cell sites. Using DWDM, a fiber can be shared with other services. There is now an ecosystem of equipment for sharing with GPON and XGS-PON passive optical networks serving residential and small business customers. End-to-end passive systems provide the stability and low *latency* required for 3G and 4G fronthaul connections using CPRI signaling as well as 5G fronthaul/mid-haul, standardized around the open RAN (ORAN) protocols. This lays the groundwork for a centralized RAN (CRAN) network architecture with the capability to deliver the full range of 5G services. Sites that continue to use a more traditional DRAN architecture will instead need a backhaul connection to the core. Backhaul data rates are much lower, easing demand for fiber capacity. Backhaul is also more latency-tolerant, expanding transport options to include various non-passive implementations.

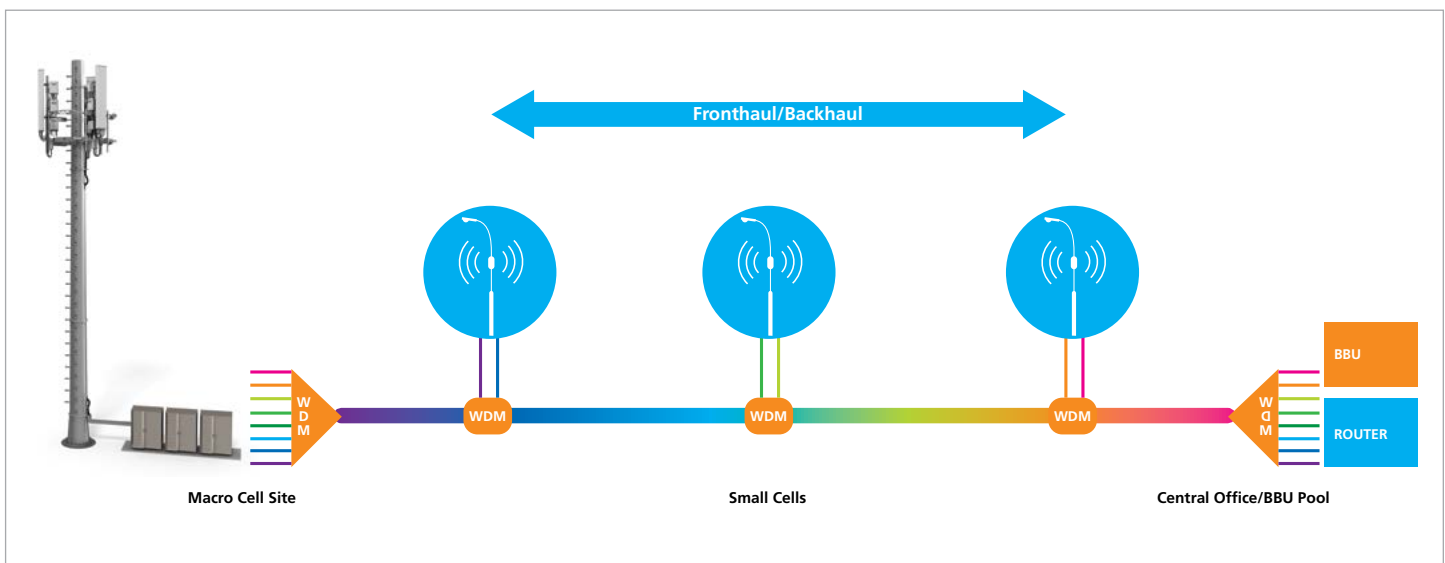

WDM applications

## The importance of putting plans and partnerships in place now instead of later

If there is an underlying theme common to all the trends and challenges of C-band deployment, it is this: to fully leverage this new opportunity, mobile network operators must evaluate their options on both the macro and micro levels.

On the macro level, the big decisions include: what role will C-band play in current and future network expectations, how will those expectations impact strategies for 5G introduction and small cell densification, what fronthaul and backhaul capabilities will be needed, what about potential risk factors such as cost and conflicts within the greater wireless landscape?

Just as important, if not more so, is understanding how these bigger macro decisions will play out on the micro level. This will require a firm grasp of advancing antenna capabilities, options for overcoming space and tower loading issues, delivering power

to a huge influx of new small cells and more. This doesn't mean network operators have to have all the answers, but they do need to know what questions to ask and have working alliances with OEMs and others who can answer them.

Fortunately, MNOs and their OEM partners have some time before they need to figure everything out. It could take another year or two for the satellite services to vacate the mid-band airspace. Plus, not all 280 MHz of the spectrum is going to be available at once—it's expected to be rolled out in two parts. So, networks will have some time to ramp up before they have to start rolling out new services. But those who wait to begin their planning may discover that playing catchup is harder (and riskier) than they imagined.

CommScope pushes the boundaries of communications technology with game-changing ideas and ground-breaking discoveries that spark profound human achievement. We collaborate with our customers and partners to design, create and build the world's most advanced networks. It is our passion and commitment to identify the next opportunity and realize a better tomorrow. Discover more at [commscope.com](https://commscope.com)

**COMMSCOPE®**

---

[commscope.com](https://commscope.com)

Visit our website or contact your local CommScope representative for more information.

© 2021 CommScope, Inc. All rights reserved.

Unless otherwise noted, all trademarks identified by ® or ™ are registered trademarks or trademarks, respectively, of CommScope, Inc. This document is for planning purposes only and is not intended to modify or supplement any specifications or warranties relating to CommScope products or services. CommScope is committed to the highest standards of business integrity and environmental sustainability, with a number of CommScope's facilities across the globe certified in accordance with international standards, including ISO 9001, TL 9000, and ISO 14001. Further information regarding CommScope's commitment can be found at [www.commscope.com/About-Us/Corporate-Responsibility-and-Sustainability](https://www.commscope.com/About-Us/Corporate-Responsibility-and-Sustainability).

WP-115348-EN (03/21)